

# Google SketchUp Design Exercise 2

At this point, students can make relatively complex designs, so it's important that they learn good design practices. One of the most important features of SketchUp is components, which are essential to use when you have objects that repeat. Components provide flexibility; they enable you to make quick changes to multiple objects at once, plus they keep the file size from getting out of control.

---

*If you need some basic information on downloading Google SketchUp, or about its user interface and basic tools, please see our printable "Intro to SketchUp" PDF.*

The PC version is at [www.3dvinci.net/SketchUp\\_Intro\\_PC.pdf](http://www.3dvinci.net/SketchUp_Intro_PC.pdf).

The Mac version is at [www.3dvinci.net/SketchUp\\_Intro\\_Mac.pdf](http://www.3dvinci.net/SketchUp_Intro_Mac.pdf).

---

1. Start with a tall building, and use **Arc** to make a half-circle on top like this (make sure the arc is drawn in the blue direction).

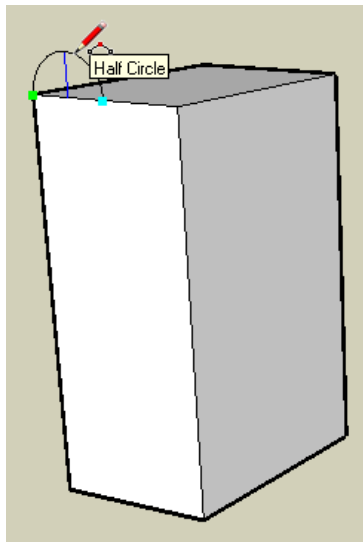

2. Pull the arc shape to the other side of the roof.

3. Then use **Move** on this edge, to make two sections of the tall wall. The lower half is vertical, the upper half is slightly sloped.

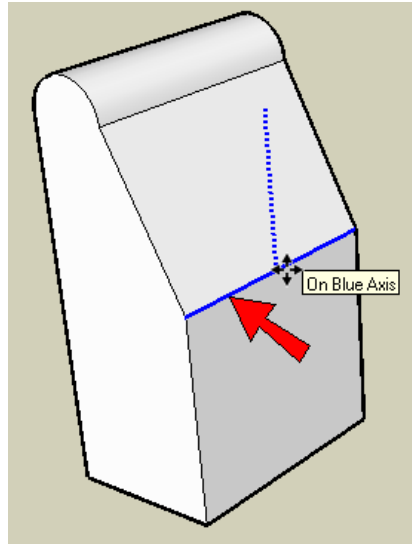

4. Paint the faces, and draw two concentric circles in this corner, to make the first window. (Remember to click the **Paint Bucket** tool to get the available colors and materials. Glass material is found in the folder called "Translucent.")

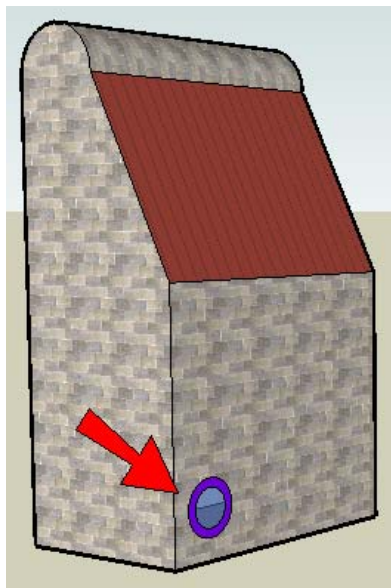

This window needs to be made into a component since we'll use it repeatedly. As a component, the window will be much easier to select - it acts as one object. (Components also have the advantage of being "unsticky" - it's much easier to move and rotate components without affecting objects they touch.)

5. **Select** both faces of this window, and right-click on either of the faces. Choose **Make Component**.



6. Give the component any name you want. Since it's a window, you want it to **Cut opening**, and also check **Replace selection with component**.

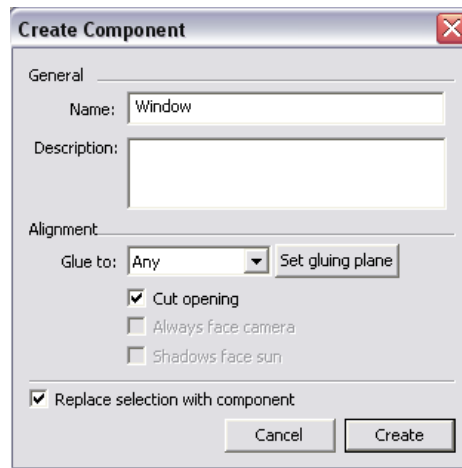

7. To add more windows, use the **Move** tool and press Ctrl / Option. After you place the first copy, type “3x” to make three copies. You can keep entering different numbers to get more or fewer windows. If you enter a value without the “x” you can change the spacing, which is also useful!

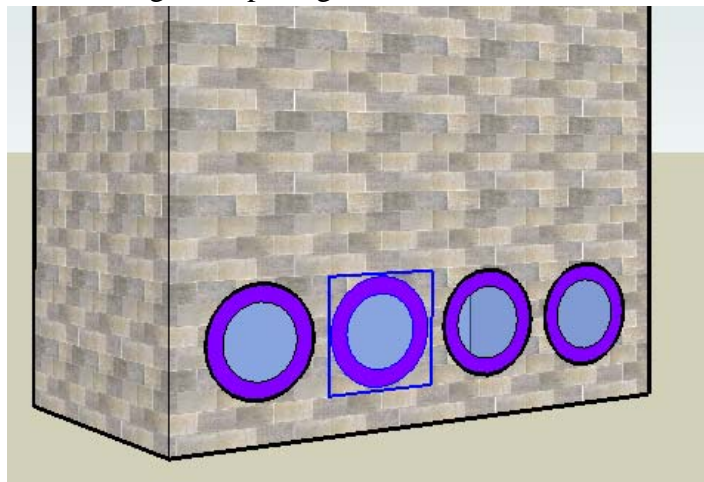

8. To make more rows in this wall, do the same thing: **Select** all of the windows in the first row, and make two or more copies of them, straight up.

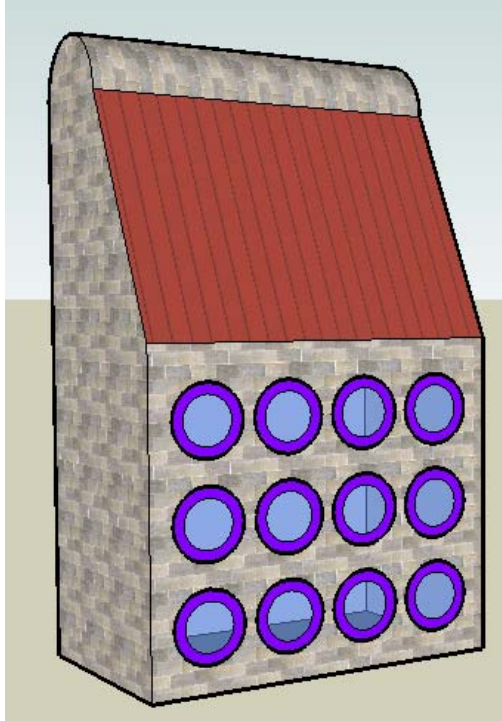

9. Copy some or all of the windows up to the sloped face. Even though the original windows make cutouts on the vertical wall, the new windows also cut the sloped wall.

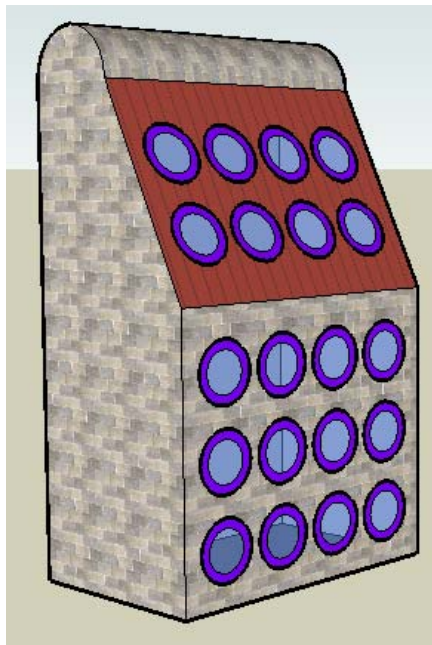

10. Another way to bring in a component is from the **Components** window (**Window / Components**). Click the house icon to see what's in your model so far. Click the thumbnail of the window, which is then attached to your cursor.

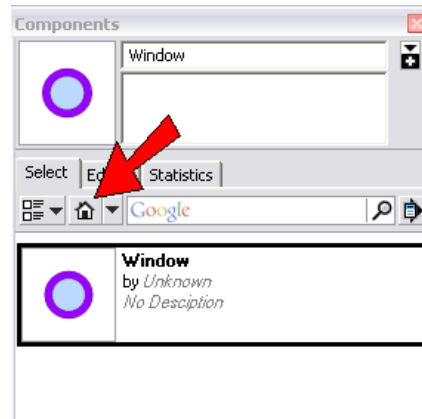

11. Place the window on this wall - it also cuts this face.

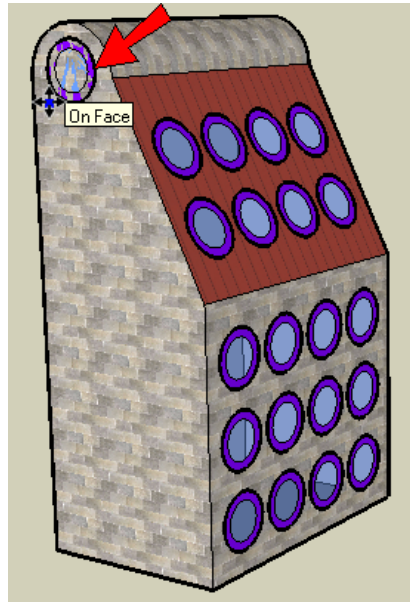

12. Here's another way to make copies. Copy that window you just added to the top, and place the copy at the bottom, near the front.

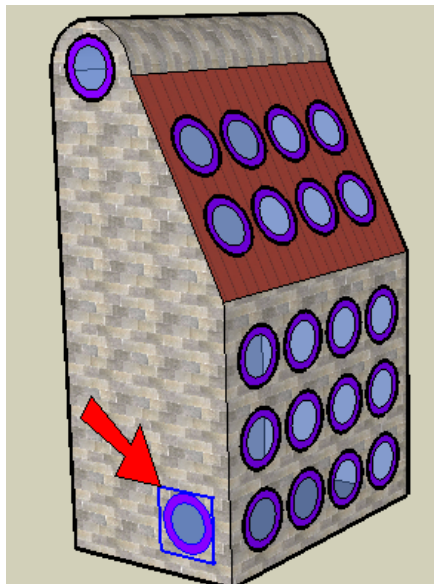

13. Enter “6/” (with a slash symbol), and you get seven copies including the first and last windows.

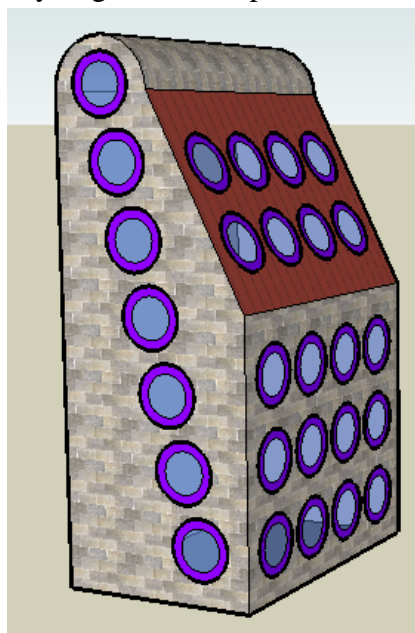

14. Here's the great feature of components: you change one, and you change them all. But you need to "open" a component before you can make any changes to it. The easiest way to edit a component is to activate **Select** and double-click it. Do this for any window - they're all the same. You'll see the one you're editing outlined in a dashed box, and everything else is faded.

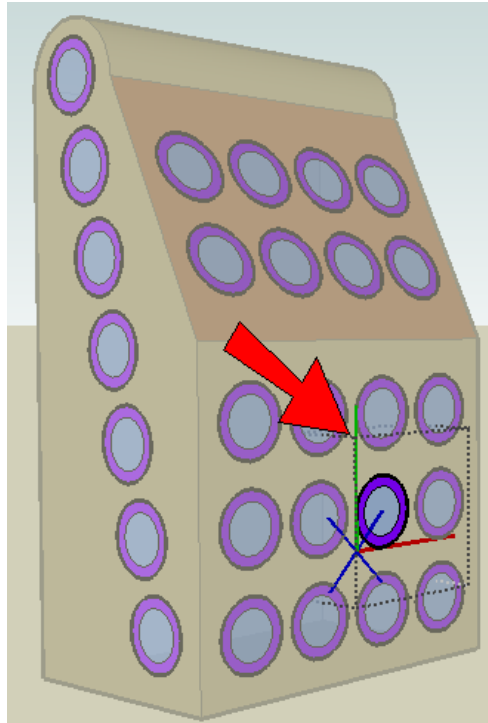

15. Use **Push/Pull** to make the outer circle into a window frame, and add some more colors.

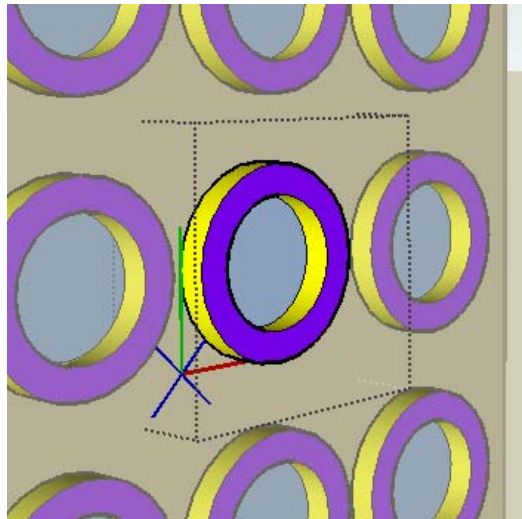

16. When you're done, close the component by activating **Select** and clicking outside the component.

17. What if you want some of the windows to be different? For instance, I want all the windows on the sloped face to have a shade cover. Select the components you want to make different (all the ones on the sloped face), and right-click on one of them. Choose **Make Unique**.

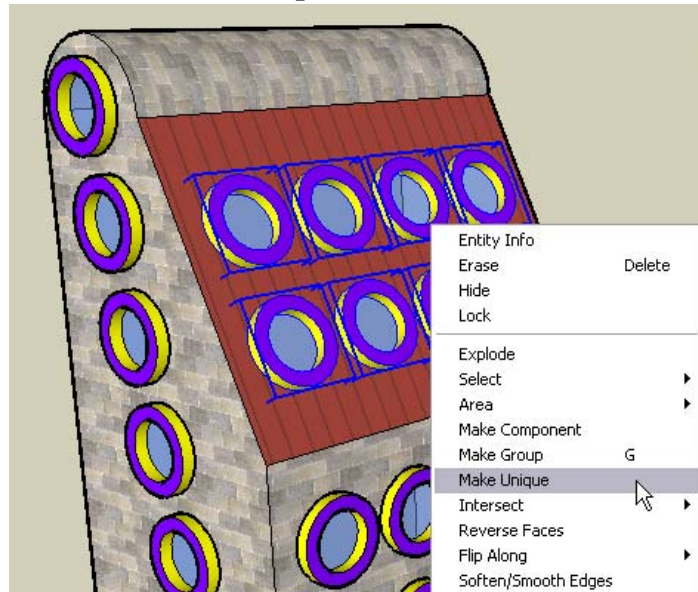

18. Now edit one of the “unique” windows. For my cover, I added two lines to the front face, and colored the top part the same as I painted the roof.

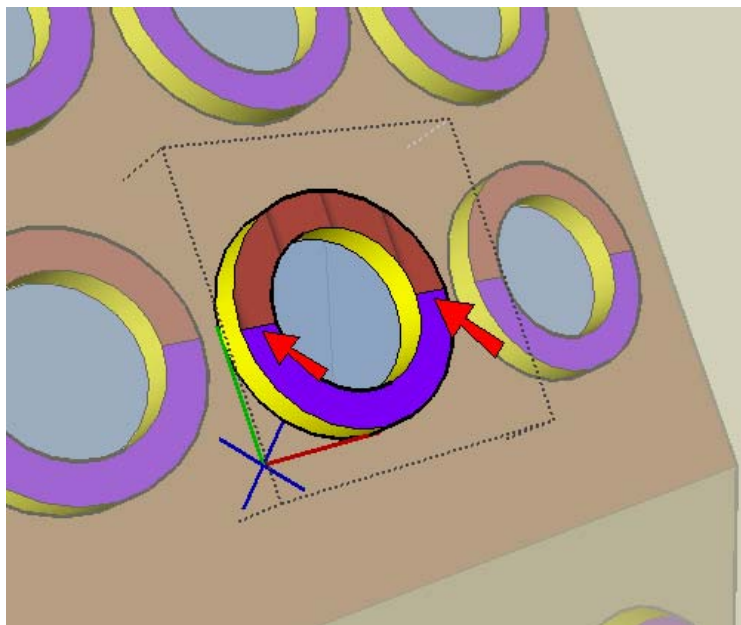

19. To make the cover, use **Push/Pull** but press the Ctrl / Option key. This way you’ll be adding a new part, instead of pulling out an existing face.



When you're done, you should have something like this:

